

### SECTION VIEW

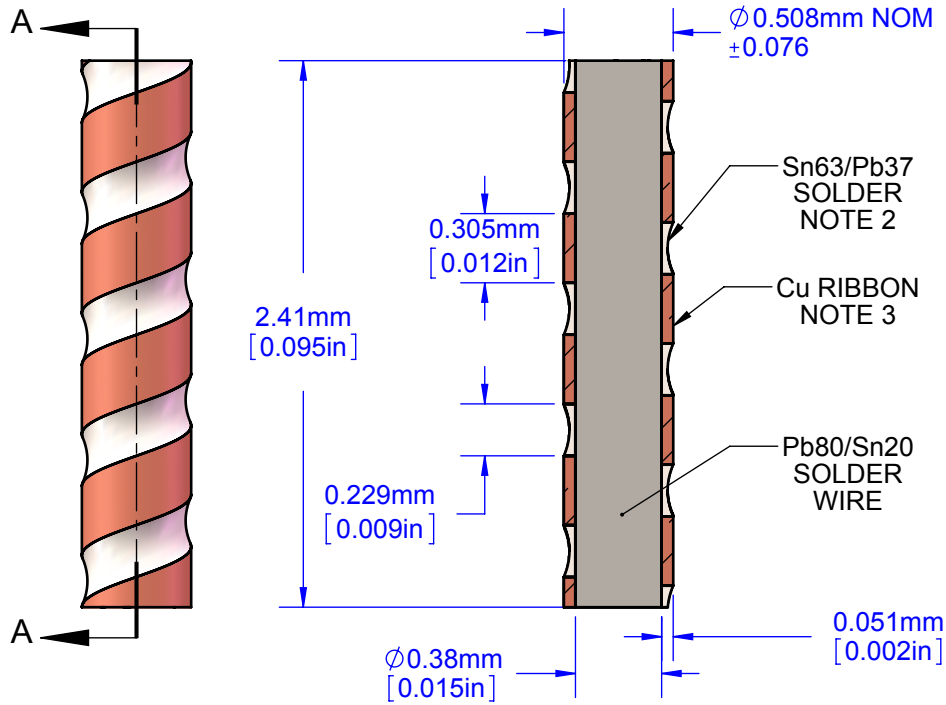

### PCB LAND PATTERN (NOTE 4)

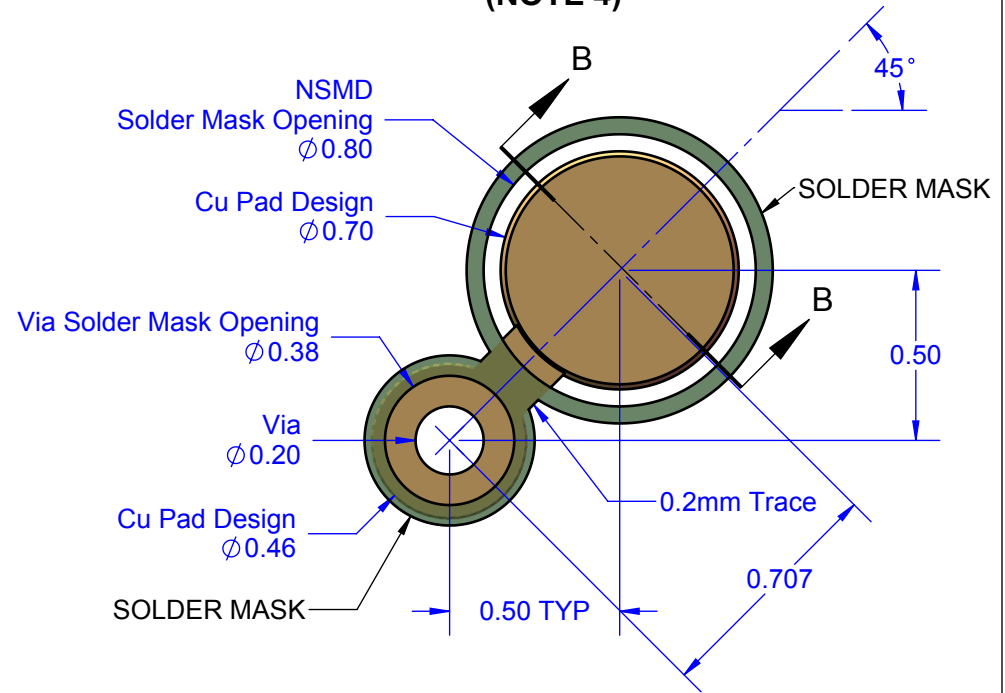

### Cu PAD SIDE VIEW

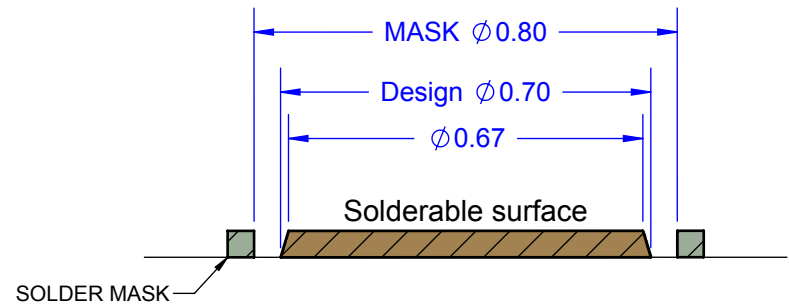

### Section B-B

### LGA - LAND GRID ARRAY PAD PLATING Ni-Au

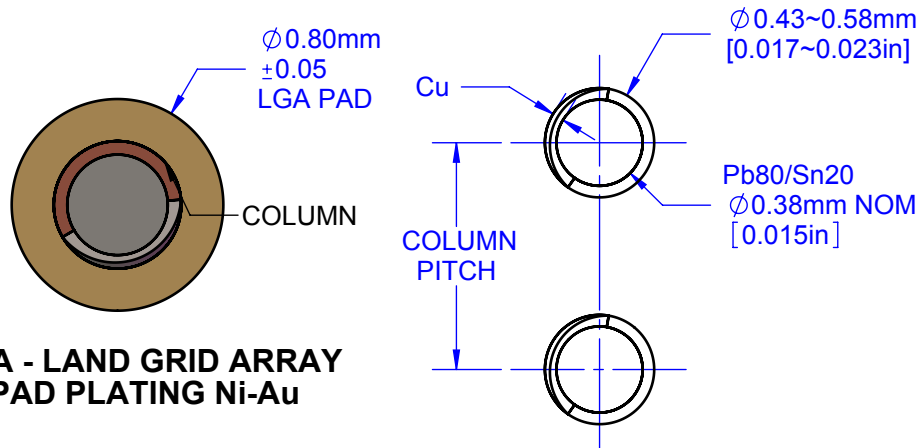

Notes: (Unless Otherwise Specified).

- 1) DIMENSIONS IN mm [INCHES].
- 2) THICKNESS Sn63/Pb37 SOLDER COAT 6~25 $\mu\text{m}$  [0.25~1.0mil].
- 3) Cu ALLOY C10100 - OFE (CDA-101). 99.99% PURE.
- 4) PCB BOARD DIMENSIONS ARE PRESENTED ONLY AS A GUIDELINE. DESIGNERS SHOULD USE THEIR OWN EXPERIENCE WHEN DESIGNING PCB.

APPROVALS	DATE	<b>TopLine®</b>			
DRAWN T. Au	02/16/15				
ENG M. Hart	02/16/15	TITLE CG8020C20x95 CCGA SOLDER COLUMN			
MFG		SCALE	SIZE	DRAWING NO.	REV
QA		20:1	A	802095	A
CUST		DO NOT SCALE DRAWING			SHEET 1 OF 1
REVISED					